

Pack 29 Pinewood Derby

Sunday January 22, 2012, 4-8pm

Check-in/Snack Bar 4-5pm/Race time 6:00pm

Location: VFW Building

8607 Mission Blvd, Riverside 92509

The Pinewood Derby is open to all Cub Scouts. Each Scout is allowed to enter one car into the derby that meets the derby rules (see below), and each family is allowed to enter one car "family car" into the race. Family Cars will be raced at the end of the derby and can be as wacky and wild as you wish, the family car has no rules except width & length– Get Crazy!

It is highly recommended that the Cub Scouts with some adult guidance should build the cars. Any technical assistance should be fully explained to the Cub Scout so that he can use that knowledge on future projects. The car must have been built in this program year; cars run in previous years cannot be raced. Good sportsmanship is expected of all participants and spectators.

Tips and Tricks for building your car can be found on the Pack website www.Pack29.net or on www.pinewoodderby.org.

DISTRICT SPECIFICATIONS & RULES

Section I. Car Specifications

- A. Width: Shall not exceed 2 3/4 inches/69.85 mm
- B. Length: Shall not exceed 7 inches/177.80 mm
- C. Height: Shall not exceed 3 inches/76.20 mm
- D. Weight: Shall not exceed 5 ounces/141.75 gm.
- E. Wheelbase: Shall not exceed 4 3/8 inches/112.71
- F. Bottom Clearance: 3/8 inches between track & car
- G. Wheel Clearance: 1 3/4 inches between wheels

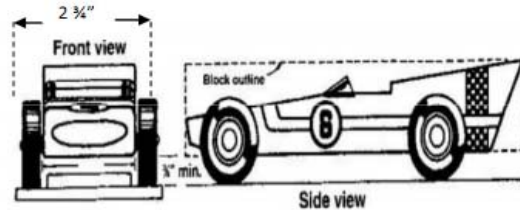

Section II. Design and Construction

A. General Design

Only the Official Pinewood Derby Kit supplied by the Boy Scouts of America will be used. Kits can be purchased from the Council Service Center or a BSA authorized distributor. Pine Car and other non-BSA kits are not acceptable. Check the kit for compliance of these rules before beginning construction. Accessories can be used as long as the car meets all specifications (see Section I). Cars must be freewheeling with no starting devices. The car must be constructed to use the track's starting system (see Figure 3). Each car must pass an inspection for compliance prior to the race and may be disqualified any time during the race.

B. Car Body

The body may be hollowed out and the use of wood or metal may be used to build the car up to the maximum allowed dimensions and weight (see Section I). Details (i.e.: steering wheel, driver, etc.) will be permissible as long as they do not exceed car specifications and are firmly in place. No loose materials or moving parts will be allowed on the car. There must be 3/8 inch clearance between the bottom of the car and the track surface.

C. Wheels and Axles

Only the wheels and axle nails provided in the kit are to be used. Modifications to the wheels are not permitted (i.e. ground to a fine line, rounded, tapered, grooved or any other kind of modification (see Figure 2). Wheels may be lightly sanded to remove the burrs and mold marks (see Figure 1). Wheels must display the words BSA-Pinewood Derby on the side walls. Only the grooves provided in the block are to be used to place the axle nails. The space between the grooves must not exceed 4 3/8 inches. If the grooves are not square, damaged or are greater than the maximum allowed space return the kit to the Council Service Center for a replacement kit. The uses of washers, bearings, bushings, pacers as well as the use of solid axles, any type of springs or suspension are not allowed to be used on the car. All four wheels must touch the track surface. Powdered Graphite or BSA Axle Lube is the only type of lubricants allowed. The uses of oil, grease, silicone or liquid graphite are not permitted.

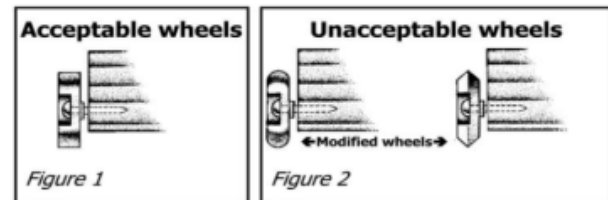

Each car must pass inspection by the official inspection committee before it may compete. If, at registration, a car does not pass inspection, the owner will be informed of the reason for failure, and will be given time within the official check-in time period to make the adjustment. After final approval, cars will not be re-inspected unless the car is damaged in handling or in a race.

All cars will be dry lubricated for you with dry graphite at check-in.

Each car will be raced 3 times on 3 different racetrack lanes. **The three electronic timings will be averaged for the final race standing.**

[Home](#)[Templates](#)

Building a Pinewood Derby Car

The Cub Scout Pinewood Derby is probably the most popular "fun event" that a young Scout will participate. The recognition of the time spent building the car may be seen as Pack prizes for the most colorful, most inventive, fastest, most "radical" and as many other categories as one can imagine. In the San Diego - Imperial council, the Cub with the fastest car in the Pack is eligible to compete with all the other Cubs from the Packs at the San Diego 500 held at the San Diego - Imperial Scout Fair.

Every year, boys with their parent's help, build cars of every description to enter at the local Pack competition. The construction of the car is intended to be a parent and son project with the son doing the majority of the work. The parent should supply the advise and limited assistance with the more difficult tasks. Please remember above all that the Pinewood Derby is supposed to be fun for all. So get started early and take your time building and testing your car. Plan to spend at least 4 to 6 hours building the car over several days. The experienced racers may spend many times this amount of time and it shows in the appearance and racing performance.

The planning and construction of your car may be approached in many ways. This information will serve only as a guide to some while providing good first-time information and pointers for others. The experienced wood craftsman will find the teaching experience a great project for a young man while the "Klutz" may find it just a little challenging. No matter, the time spent working and learning with your son should be a lot of fun.

If you're designing a car for speed here are the important points about car design to keep in mind.

- o **Sleek Shape**
- o **Maximum Weight**
- o **Smooth, Round Wheels**
- o **Polished Axles**
- o **Good Lubrication**
- o **Straight Running**

On the other hand if your objective is to create a unique or personal design then think about these

points.

- o Model your car after something you like or adapt a theme from a Cub Scout or other recognizable object or character.
- o Use color and finish as a way to get your car noticed. A bright red or yellow paint job with a high gloss finish is always an attention-getter.
- o Attention to the details of car construction shows in the final product
- o Design on paper before you start cutting wood

Construction Step 1 - The Plan (or What *are* we Doing?)

You may already have an idea as to what your car should look like when you're done but in order to take this idea to a completed form you should have a plan. Take a little time to sketch out your idea on paper. If you haven't decided what you want to do you may want to check out some possibilities. Look at the profiles provided in this guide to get some ideas. Draw your design at full scale so you can transfer the profile and shape to the wood block later. Ready-made templates or car outlines can be purchased at Scout supply outlets, the Scout Shop or Scout mail-order catalog. These will help you transfer a predefined profile to your car but are certainly not required. You may want to take a look at the [templates](#) in this web site for some ideas.

Starting with a block of wood is like a hand full of clay. What are you you going to do with it? What kind of car do want to build? Well, there are several basic types of car classifications cars that are fast, cars that are fast to build and then there are character cars. Character cars are cars that model other types of cars or objects. Remember that a highly decorative car with characters, decals and other trim will not be as aerodynamic as a "plain" car. The sleek low profile designs will tend to have less wind drag and therefore faster. The fast car is *usually* not a handsome car. Don't limit your design ideas but we'll talk about the plain, more aerodynamic designs and remember, you can paint car just about any way you you'd like.

Construction Step 2 - Gather Materials and Tools.

You will, of course, need the basic car kit that includes the wood block, axles, wheels and numeric decals. They cost \$3.55 + applicable tax in the 2005 catalog. The kits produced since 1998 have unpredictable quality wheels in the kit and that may make it more difficult to produce a fast car every time. If you have still have an older kit it may be used as long as it is the Grand Prix series racer kit. ***Do not substitute the wheels and axles from non-BSA kits into your car design.*** This will make it illegal in most races and you can be disqualified.

You will need the following tools and additional materials:

- Safety Glasses (for drilling, sanding etc.)



- Coping Saw (A Powered Dremel Saw or Scroll Saw may also be used)

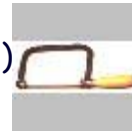

- Small File (Mill or Fine Cut)



- 3/8"/10 mm Drill Bit (a Brad point bit gives you better hole positions)



- Electric Drill Motor



- Tracing Paper

- Small Strip of Soft Cloth (like an old Tee Shirt)

- 80 Grit and 220 Grit Garnet Sand Paper



- 400 or 600 Grit Wet or Dry Paper

- Metal Polish (for polishing the axle)



- 3/8"/10 mm Tubular Weight (Available from Scout Shop or plumber supply)

- Wood Putty (or better yet - plastic auto body filler)

- Sanding Sealer or wood Primer

- Finish Paint (Either Spray or Brush on)



- Decals and Decorations as Desired



This set of tools and materials will vary depending what you have available and the extent of work you have in mind.

Construction Step 3 - Cutting the Basic Car Shape.

Decide how you want you car to look. Again, you may want to refer to the [templates](#) in this web site. When you have a design idea it's time to transfer the profile (side of the car) and plan view (top of the car) to your block of wood. The block included in your kit is usually close to 7 inches (17.8 cm) in

length but may vary a little shorter or longer. Be careful to measure the final overall dimensions of the finished car to insure that your design does not violate the racing specifications.

Using your side profile drawing and a sheet of carbon tracing paper align the drawing to the block and carefully trace the outside lines of your car so that the image is transferred to the wood. If you prefer, you may find it just as easy to copy or duplicate your lines on the wood directly. Use a hard lead pencil or ball point-pen so that the lines are easy to see when you're cutting.

Construction Step 4 - Wheel Mount Preparation.

It's been discovered over the years that cars with a longer wheelbase can be faster than shorter wheelbase cars. With this in mind you may want to consider relocating the two axle slots in the car block toward the ends of the block. *Perform this modification only if your pack or local rules permit it.* The San Diego 500 rules *do* permit this change.

Remember to set the wheel slots back at least half the diameter of the wheel so that it doesn't extend over the end of the car body. The overall length of the car (including wheels) cannot exceed seven inches. It is *very important* to cut the new axle slots exactly square to the sides of the block so that the axles provide a good alignment for tracking. An alternate method is to use a drill press to make the holes but in either method make sure that the final position of the axle isn't too high so that it creates a problem for the block dragging on the track's guide strip. Use a #43 (2.3 mm) drill bit. Insert the axles in each of the slots or holes so that you know they'll fit later. Install the axles at the top of the slots so that they have plenty wood under them. Now that we have opened the wood fiber remove the axles. We'll permanently install the wheels and axles after the paint has dried.

Construction Step 5 - Drilling Holes for Weight.

Your finished wood block along with the, wheels, axles and trim will not usually weigh much over 2.5 ounces (71 grams) while the finished car is allowed to weigh in up to 5.0 ounces (141.75 grams). ***Don't even think about skipping weight addition if you want to be race competitive.*** The weight of your car overcoming friction is what will allow you to win over other cars. You must make gravity work for you. Your car must overcome both breakaway friction and minimize air resistance and it will do this by being as heavy as allowed while presenting the smallest profile to the air-stream. That's why we wanted the low and skinny body design.

There are two basic approaches to adding weight to a derby car. The easiest is to attach pre-drilled and shaped lead or zinc weights to the outside of the car. Some of the commercial varieties are cast such that they provide a tapered shape and break-off ribs that permit convenient adjustment to overall weight after the car is assembled. It is best to attach this type of weight to the bottom of the car so the center of gravity may be kept low. If you use this type of weight on the bottom of

your car *insure that the weight doesn't hang down too far*. It may not be obvious until race-day but the weight could drag on the track guide. This could prevent the car from moving off the the starting line. Mortise or "hog out" a void in the wood on the underside of the car and then attach the weight inside the void.

The other method for adding weight involves the installation of weight internal to the body so that there is no additional wind resistance. This may be only a small advantage but it just might make the difference of a winning inch or two at the end of the track. Most car profiles will be narrower at the nose and provide little space for adding lead internally. There is an advantage in placing the weight in the back. The front wheels perform the function of guiding or steering and the less weight on these wheels the easier the car corrects itself when it strikes the guide strip. ***Fewer and shorter contacts with the guide strip means a faster car.***

Drilling the Car Body. Each internally weighted car will have a little different cavity placement based on the wheel/axle position and amount of wood available to accommodate the weight. The hole or cavity for the lead weight must be large enough to accommodate the weight you using. You will need fewer holes for lead than you will for other materials. Plan on drilling at least 2 or 3 holes of 3/8" (10 mm) (or 7/16") diameter at a depth of 1 1/2" (38 mm) each. Experience has shown that holes drilled from the side or back tend to work the best. Locate and drill the holes being careful not to drill all the way through the wood. Also make sure that you are leaving enough wood around the hole to provide a margin of safety in your drilling operation.

Construction Step 6 - Adding the Weight.

There are many things that you might use to add weight to the car but you will find that lead and zinc will probably be used most often. These are the heaviest materials easily available for their volume. Lead works easily and is commonly available in a number of forms. As options you can use steel in plate, tubular forms or even common bolts. Other metals may be used but just as steel you will find them difficult to work and sometimes awkward to attach or insert.

Warnings

Lead is toxic and should be handled as little as possible.

Use gloves and never put your hands in or near your mouth

after handling it. Always wash your hands thoroughly after handling lead.

Do not use mercury at all! It is toxic, difficult to handle and should not be touched by Cubs or adults.

Weigh your car on accurate scales. Most household scales are not very accurate. If you have access to calibrated scales compare a known item weight on the calibrated scales to your home scale indication for that same item. Mark this reference for use later. Allow for scale inaccuracies by not adding to exactly the 5.0 oz. (141.75 grams) indication. ***It is better to be slightly light than to have to remove weight on race day.*** Consider also, while you may have an accurate scale your *pac* may not. It could be weighing items heavier than they actually are!

Weigh your car body, wheels, axles and any other parts that will be on your car all at once. This weight is usually less than 3 ounces (85 grams). Now, with your car lying with the weight holes facing up carefully add your weight until the weight is just over 4.5 ounces (128 grams). Allow enough space in the holes so that you can add filler material in the next step. If you find there isn't enough room to add weight to get to 4.5 ounces (128 grams) you will have drill an additional hole or holes. Remember, you will be adding wood filler and paint to your car later and this will a little more weight. When you are satisfied go to the next step.

Construction Step 7 - Sealing the Holes.

Once that you have got the correct amount of weight installed you are ready to seal the hole(s) in your car body. There are a number of materials that you can use to cover the weight holes in car body. If you are in a hurry and want to insure a good seal try using automobile body putty (like Bondo®). This type of filler material is a two-part mix that sets in 15 minutes. You will need only a small amount but it works very easily and may be sanded, drilled and painted. Standard wood fillers that don't use a catalyst will take longer to harden (usually overnight) and may need to be applied with several thin coats. Apply the filler so that it may be sanded down smooth to the original wood surface. You'll want to recheck you total car weight at this time.

Construction Step 8 - Sanding and Smoothing.

Sanding the wood body will eliminate any of the saw blade marks as well as any small blemishes in the wood surface. If you have access to a motorized belt-disc sander your work will be quickly done but for most of us a sheet of sandpaper and a sanding block will do just fine. Start by using a 100 or 120 grit paper and wood or rubber block on the filler and rough portions of the wood car body. Gently

smooth the edges and corners of the car while using a little more pressure on the flat areas. Then switch to a 220 grit paper to smooth the sanding marks left from the initial sanding. When you have the wood smoothed switch to the 400 grit paper. It will provide an excellent surface for your final finish. DO NOT WET-SAND UNPAINTED WOOD.

Construction Step 9 - Painting and Finishing.

The bare wood surface will act much like a sponge when your paint is first applied and it will take several coats of paint to seal and finish the wood. A better approach is to apply a wood sanding sealer to the wood. This acts like a primer coat for the wood and provides a good base to apply the color finish paint.

Prepare a place to paint your car that will be out of the house while you are painting and out of the reach of younger children while your car is drying. You may either paint one side at a time waiting between coats or suspend the car on a string with a nail in the axle slot and paint all of it. Brush or spray the sanding sealer on the car with a complete coat and wait for it to thoroughly dry. You will see that the grain of the wood will raise slightly. After the paint is thoroughly dry, sand it with 400 grit wet or dry sandpaper. You will find that the finish is smoother if you use a wet-sanding process. Wet the paper and the painted car body. Lightly sand until the sanding-sealer is smooth but not through the sealer to the wood.

You are now ready for the finish color coats of paint. The best and smoothest finishes will be had with a spray paint but brush-on paint will not effect the overall speed of the car. Use fast drying enamels and avoid using different brands on top of each other. Above all don't use lacquer paint on top of enamel paint. Your paint will wrinkle and bubble. If you get a run in the paint, let it dry and sand it smooth. Re-coat it later. You can achieve a very, very smooth finish if you wet-sand between coats with 600 grit wet-or-dry sandpaper. Your car can look like it has a glasslike finish with several coats of paint and fine sanding.

If you are going to apply decals and detail work now is time to do this type of work. If you are careful, you can apply a clear coat of finish over the decals to seal them. Don't use too much clear-coat at one time or you'll wrinkle the decals.

Construction Step 10 - Wheel Work.

Next to the weight of the car the wheels are the most important element in the car. The biggest problem is that there is not a great deal that you can legally do with them. You must insure that the wheels roll smoothly, in a straight line and roll very easily. The wheels included with kits manufactured through 1998 have a better quality wheel than that of previous kits. Kits produced in the 1999 race year were very inconsistent. Even still, there are things to check and fix on each of

the wheels. First, the wheels must be perfectly round. The wheels are produced in Multi-cavity molds and some molds may produce slightly out-of-round wheels which will be slower than others. To check for this put the wheel on an axle and spin it. It should turn with the outside surface at a single reference point never varying. The run-out or the wheel movement along the axle axis should also be minimal. If you suspect the wheel is out-of-round discard it and buy just the axle-wheel kit (\$2.35 for 5 wheels and axles) or another car kit at your Scout supply outlet. There isn't much you can do to correct a bad wheel. The wheels are all produced from a mold set and will all vary to some degree.

Check the wheel for burrs on the running surface of the tire and hub areas. These need to be freed of any extra plastic residue or molding marks. Most Packs and council races require the racers to do minimal work on the wheel surface. This means that the outside wheel surface can be sanded or filed to make it flat across the bottom of the "tire". To perform this work you may use either a very small machine screw or nail about 3 inches long to stack all 4 wheels onto and chuck them in to a drill motor. Using a fine flat mill file, turn the drill on and at an angle to the rotating wheels, apply very light pressure to the wheel surface touching at least two wheels at a time. Insure you don't create a rounded wheel surface which may be illegal. Alternately, purchase a commercially-available wheel turning kit from the Scout supply distributor or Pinocar® source. These wheel turning mandrels are designed to hold a single wheel in a drill motor for turning. Watch for the newer wheels with these mandrels, they may not fit. Again, observe the local rules for what may be allowed.

Construction Step 11 - Axle Polishing.

The 'nail' type axles that come in the Pinewood derby kit must be used in the construction of your of your car. These axles provide no bearing surface so there is friction between the plastic wheel surface and the metal axle. Since this friction reduces speed we need to minimize the contact surface area, make the surfaces smooth and lubricate the mating surfaces. It is usually against the rules to machine the plastic wheel and these procedures usually require a lathe or other tools not typically available to a Cub Scout. That still leaves the axle open to "play with". The following suggestions are things you can do with simple hand tools to improve the performance of the axles.

Axle Burr Removal. First, the heads of the nails used as axles in the kit will often have a mold or casting mark in two places just where the head attaches to the shaft the nail. Remove this web of metal with a file being careful not to gouge or scratch the running surface of the shaft. This will prevent the axle from grinding the plastic hub area and slowing down your car. You might be surprised to how "out of round" the shaft of the axle really is. Chuck/secure the axle in a drill press or electric hand drill secured into a stable position.

Optional step. This step can be performed before actual polishing but is designed for those creating "the ultimate" racing machines. It's not necessary for the average racer. Use a fine flat file to reduce the overall diameter of the axle. To do this, chuck the pointed end of the axle into a drill press or drill motor that has been secured with a vise or clamp. Place the file against the rotating axle and apply even pressure while moving the file slowly. Do this until the area within $\frac{1}{2}$ " (10 mm) of the head is smaller than the rest of the axle body. The more metal that is removed the less contact surface available to create friction. The drawback to removing too much metal is that the axle becomes weaker and will not tolerate being dropped or withstand rough handling without bending. This is often a trial and error procedure with much testing required to result in a fast turning wheel. You will want to buy extra axles to try this and use the best of the lot for your car.

First-Surface Polishing. The axle can be finished to a high luster by following the steps detailed here. First, mount the axle in drill motor chuck exposing the head and the first $\frac{3}{4}$ " of the axle. Secure the drill so that it doesn't move. Now cut a piece of 400-600 grit wet or dry sandpaper to a strip approximately $\frac{1}{2}$ " (10 mm) wide and 4 to 6 inches (about 100mm) in length. Wet the surface of the sand paper with water or light machine oil, start the drill and loop the sandpaper over the axle and pull the paper back and forth like a shoe polish cloth. Work the paper until the metal is smooth in the wheel running area (next to the head of the axle). This usually takes about a minute for each axle. Now, using either pumice paste or metal polish in a soft cloth (like a tee-shirt), start the drill again and press the cloth and polish compound into the axle with a slight movement back and forth. This will also take about a minute. The finished axle will be very smooth and bright in appearance

Construction Step 12 - Lubrication.

The type of lubrication is usually restricted at most races to dry lubricants but there are great advantages to using the right lubrication. By the same token there is harm in using the wrong lubricate. First, we should discuss what it's all about.

The wheel should turn on the dry axle without any undo force but the friction between the two parts will quickly act to slow it down. It's this friction that you would like to eliminate. While we can't eliminate friction completely it can certainly be reduced. An automobile uses steel roller or ball bearings to reduce friction on its wheels but our car isn't permitted to use them. We can only lubricate what we already have. A lubricant is any agent that provides a reduction of friction. While there are many types of lubricants many will either not work on lightweight parts or are not formulated to work with plastics. Petroleum products such as motor and household oil may soften the plastic wheels. The wheels could, after a time, fail to turn at all. This is not the surprise you'd like on race day. Other liquid or aerosol lubricants include spray-on Teflon, WD-40, CRC and 3 in 1

oil. Except for Teflon, these are all petroleum based products which you'll want to avoid.

The most common and successfully used lubricants are the graphite formulations and Graphite-Moly blends. They provide a very thin plating of microscopic spheres that greatly reduce rolling friction. Plain graphite is available in hardware stores and some variety stores. When installing your wheels fill the axle hole of the wheel while capping the other side. Gently push the axle through the wheel. Do this several times and spin the wheel to help distribute the graphite through the running surface. A good test of the wheel, axle and the lubrication is a spin test. While holding the wheel in the axle in a horizontal position spin the wheel with a flick of your finger. It should spin freely, then slowly coming to a stop after 20 to 30 seconds. If it didn't spin that long take a close at your wheel clearance, axle finish and lubrication. Correct the problems than test them again.

Construction Step 13 - Wheel Installation and Alignment.

The guide strip on a pinewood derby track will keep the cars on the track and prevent them from hitting each other. This strip is necessary but each time your car's wheels hit it the car slows down a little. This is where wheel installation become important. If the car runs straight it will less often hit the guide strip.

There are a number of little *tricks* to consider in this stage of the car building. First, while you must run all 4 wheels they all don't necessarily have to touch the track surface. If each wheel has rolling resistance don't roll *all* of them. Simple. Usually, the best one to elevate off the track is one of the front wheels. Second, to prevent additional rolling resistance install the axles at an angle to the body so that wheels ride the end of the axle not against the car body. Install your wheels so that there is clearance between the body and wheel and insure that the car body surface has a hard finish (No washers though) next where the wheel hub might touch the body.

Test roll the car so that you are satisfied that the car rolls in a perfect line. Put the car on a flat board or other smooth surface that has a straight line scribed for reference. Lift the board so that the car begins to roll. It should roll very close to the line. If it doesn't, then a front end alignment is required. Slightly bend the wheel axle(s) to correct the drift.

Checking Alignment. Another test using a long smooth surface is to check for tracking or wheel alignment. Draw a straight reference line on your surface and place the car on the surface with the wheels on top of that line. Now elevate the surface to the rear of the car to start the car rolling. Your car should roll along the that line is its tracking straight.

Construction Step 14 - Other Testing.

Now that you have finished construction and initial wheel alignment of your car you will want to test

and re-test your car

Ideas from 2009 Pinewood Derby





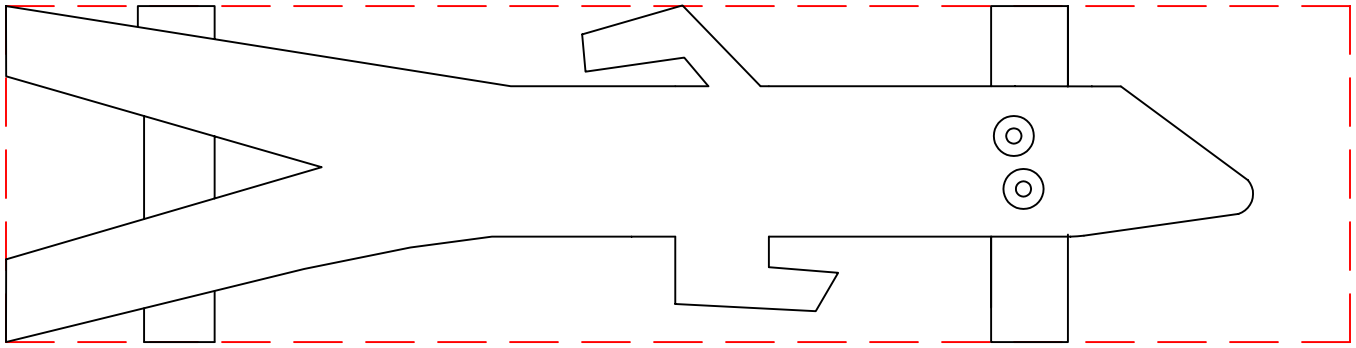

GUMBY

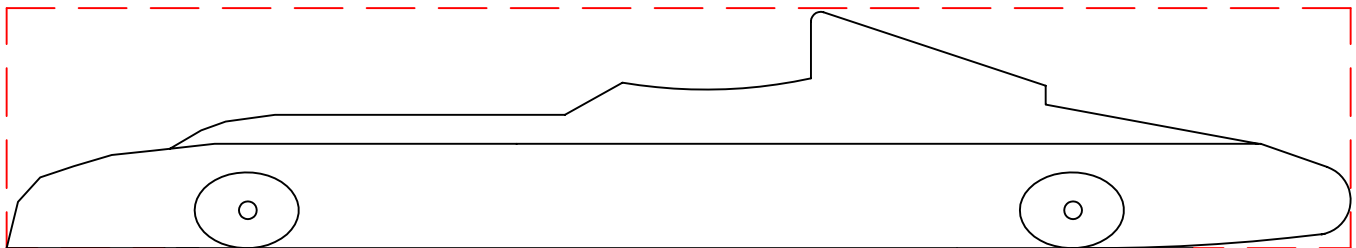
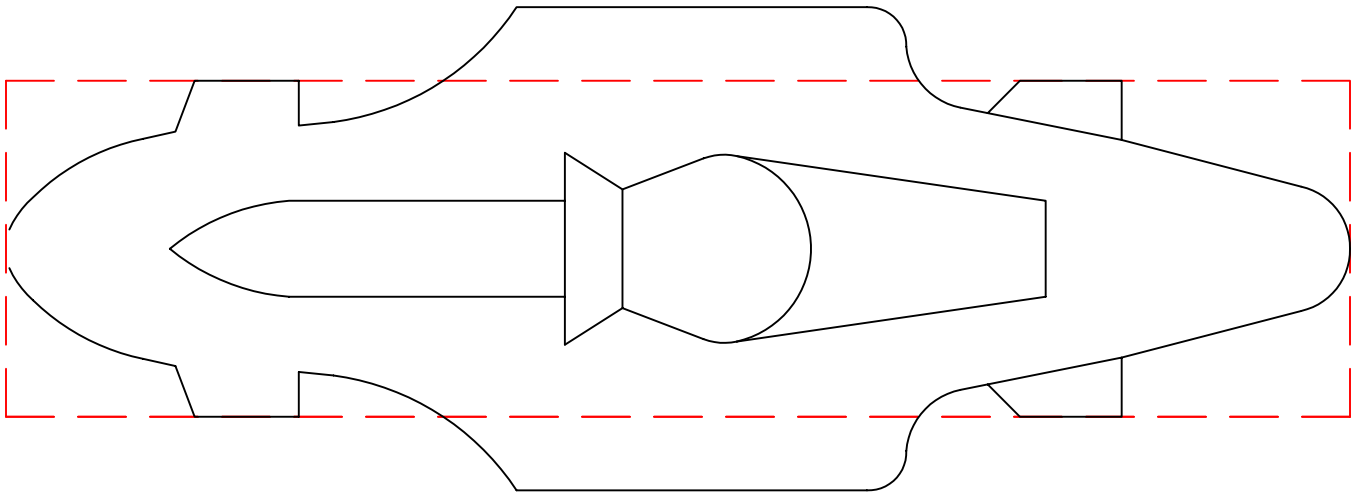
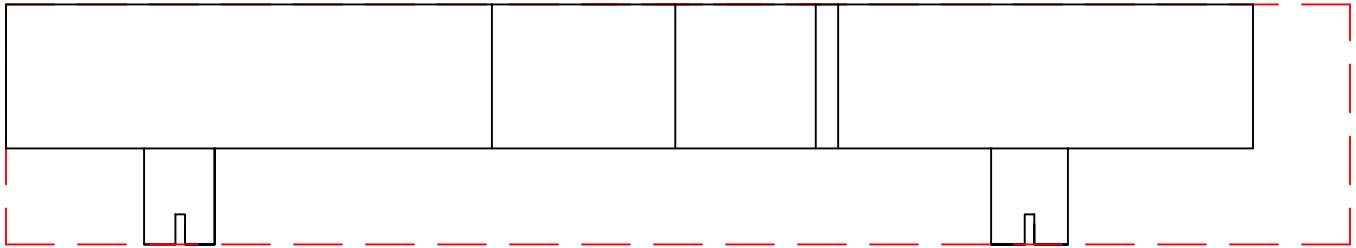

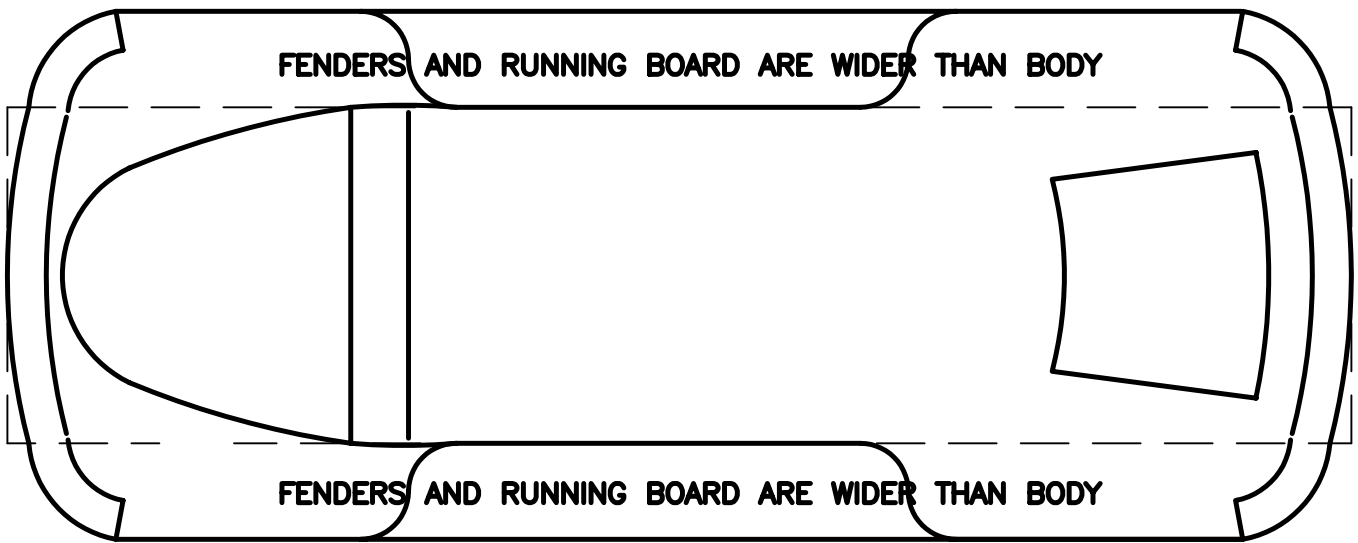

"BUG TOP VIEW"

ADD EXTRA WOOD FOR HEIGHT AND WIDTH

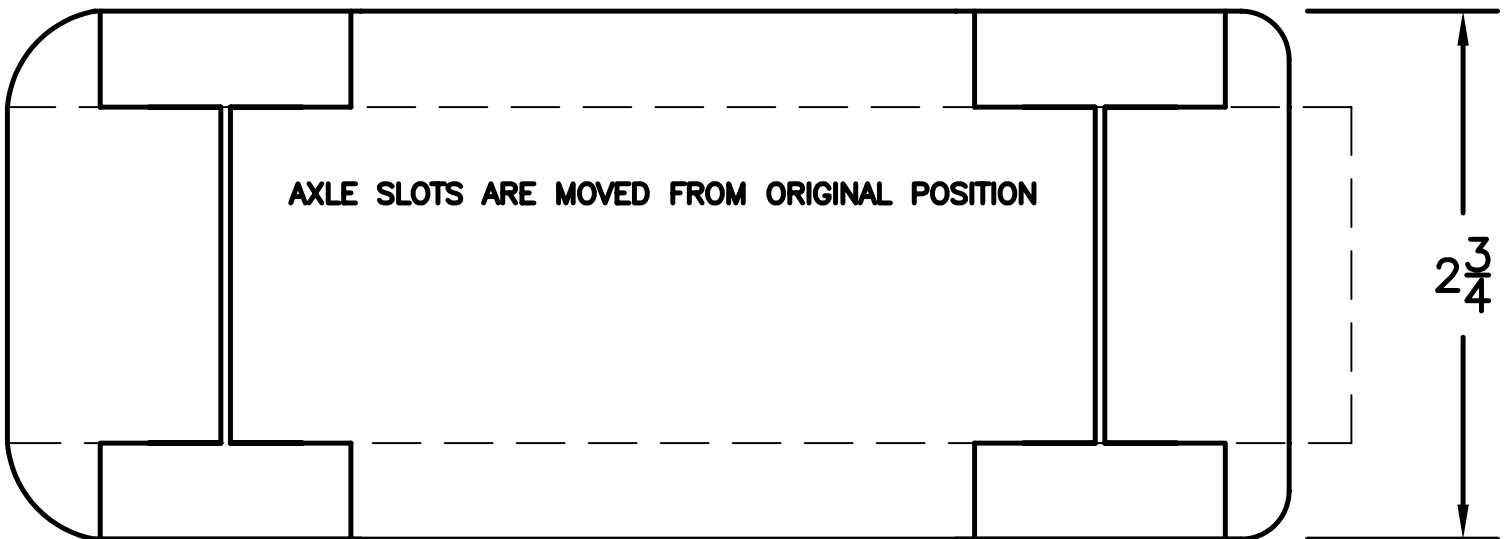
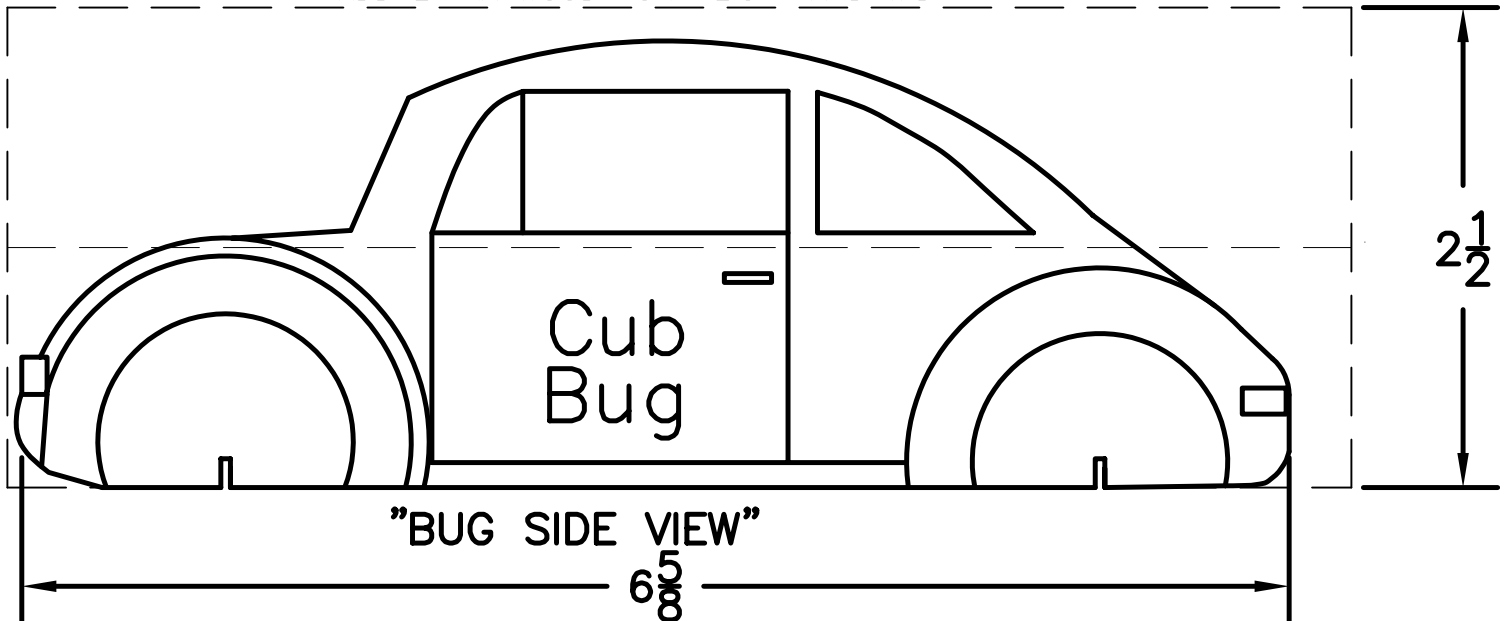

"BUG BOTTOM VIEW"

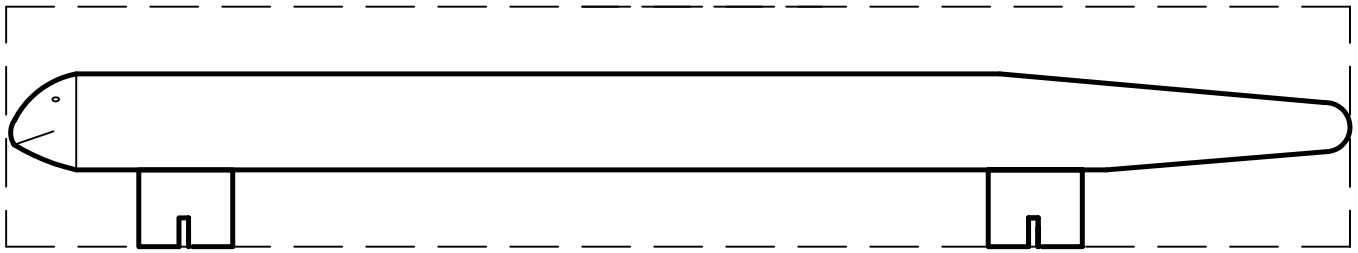

"SNEAKY SNAKE SIDE VIEW"

FRAGILE DESIGN, USE REINFORCEMENT

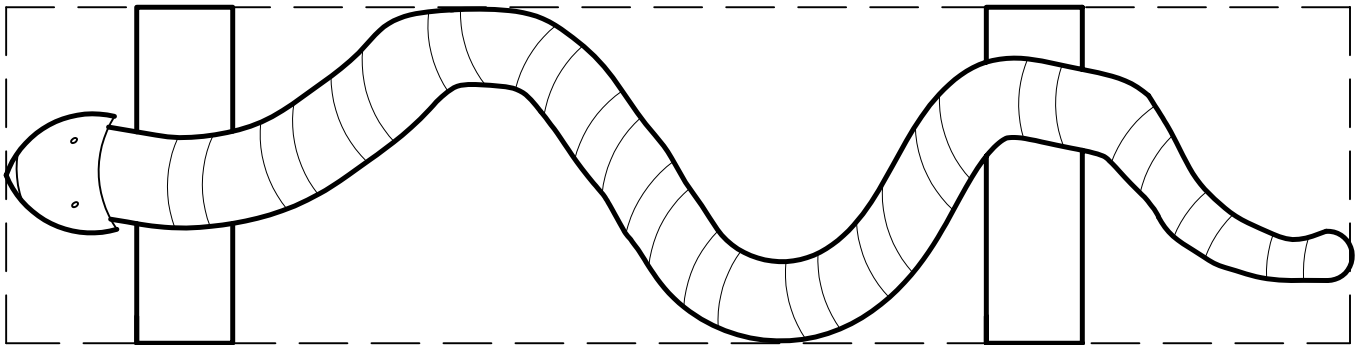

"SNEAKY SNAKE TOP VIEW"

1/8" WOOD DOWELS

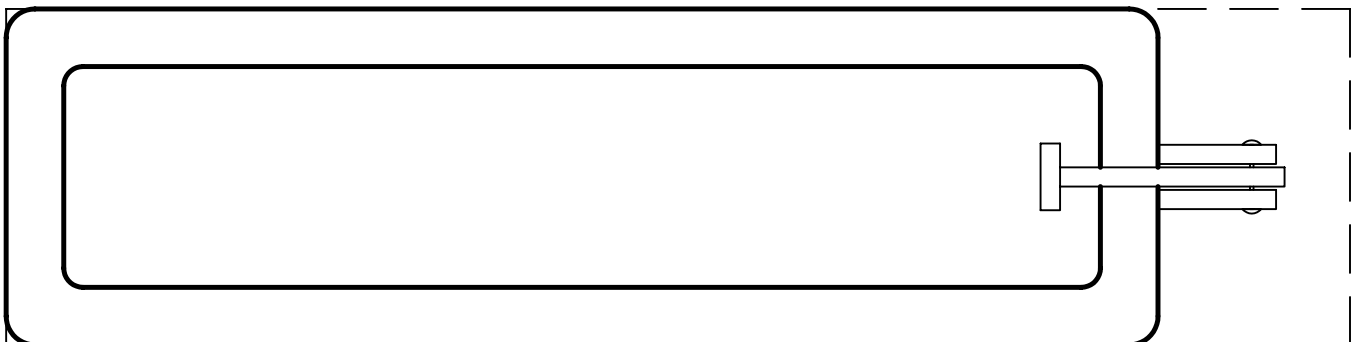

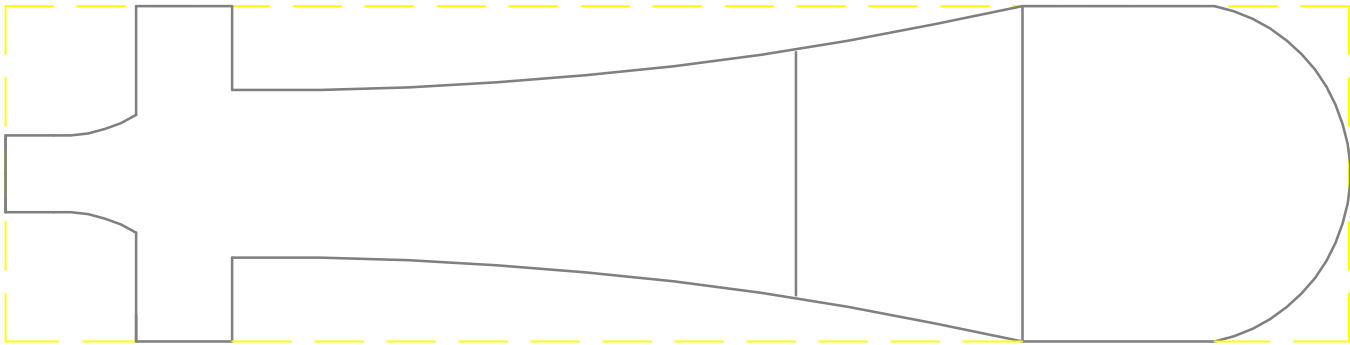
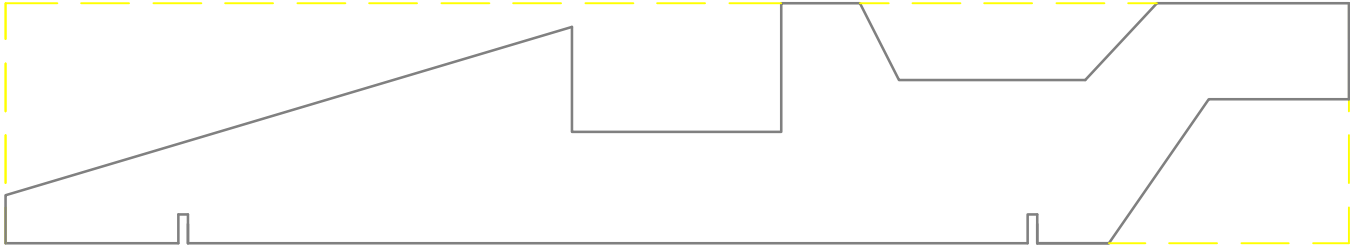

"DRAGSTER TOP VIEW"

"DRAGSTER"

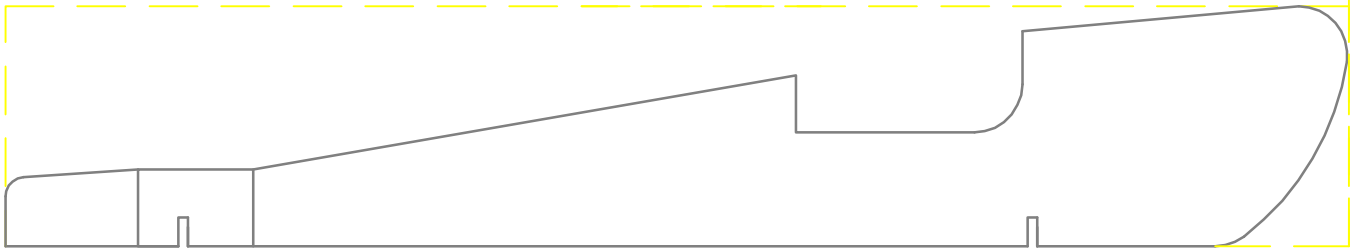

"SLOW SHORT STUFF"



ADD WEIGHT IN 3/8" HOLES

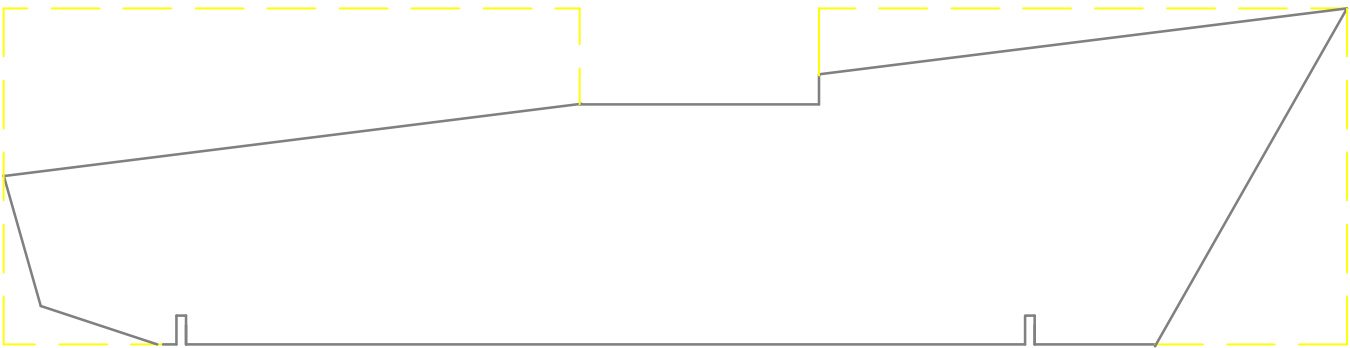
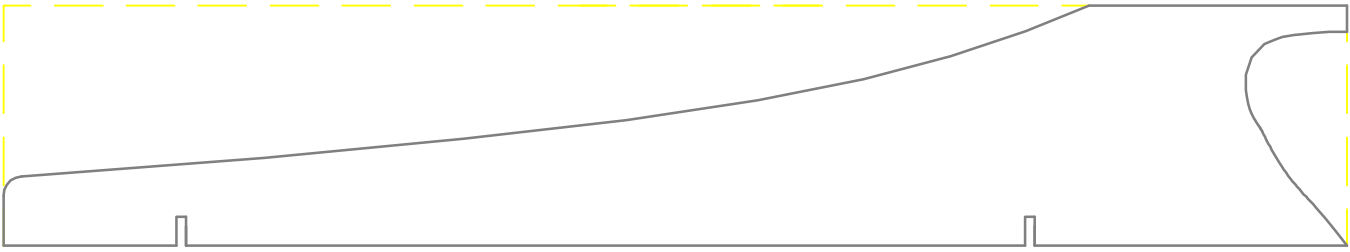
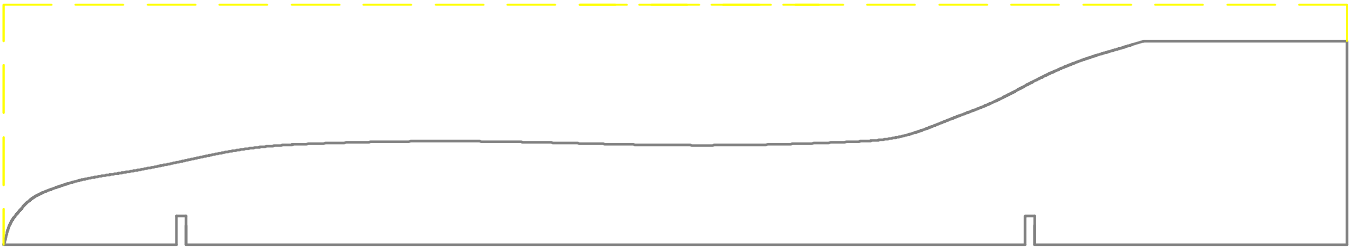

OLD STYLE BLOCK

MINIMOUSE – CUT PROFILE THEN SHAPE BODY

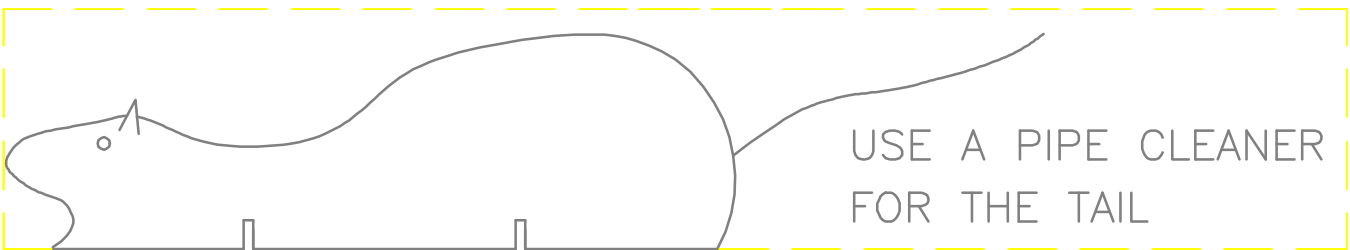

USE A PIPE CLEANER FOR THE TAIL

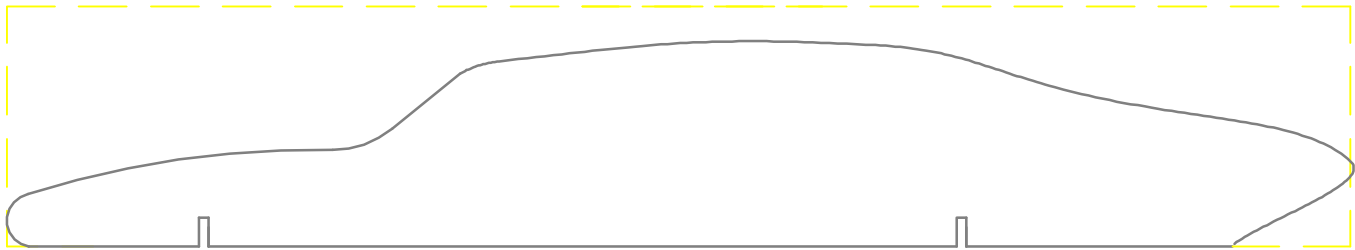
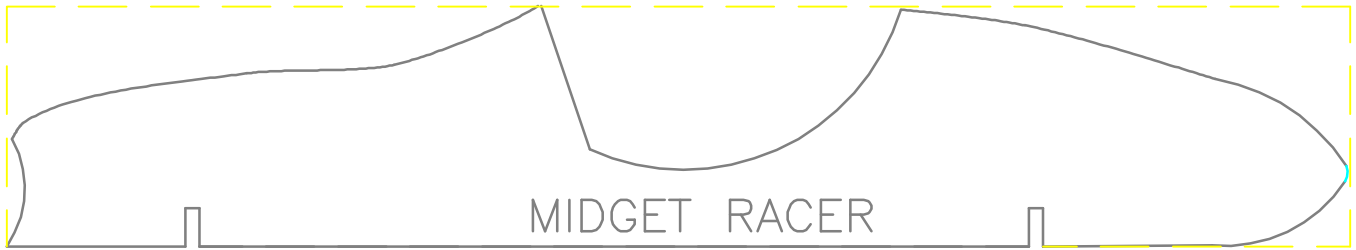
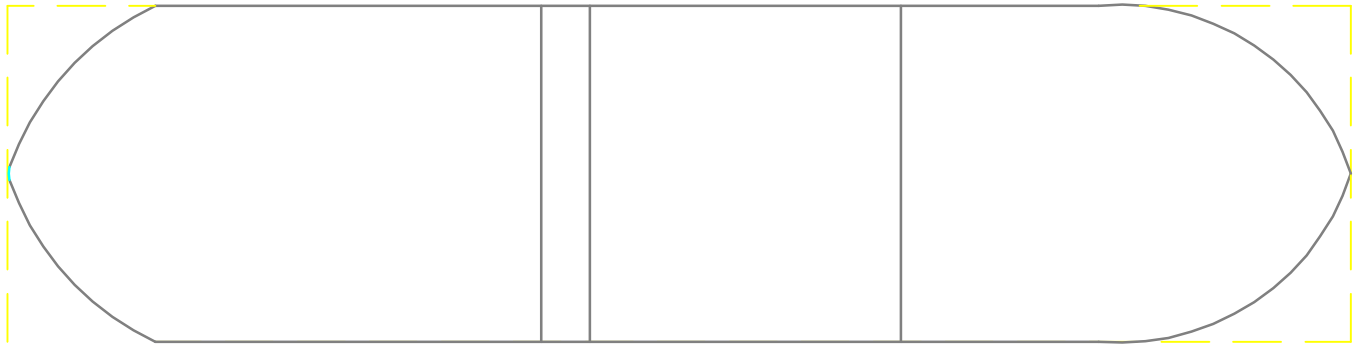

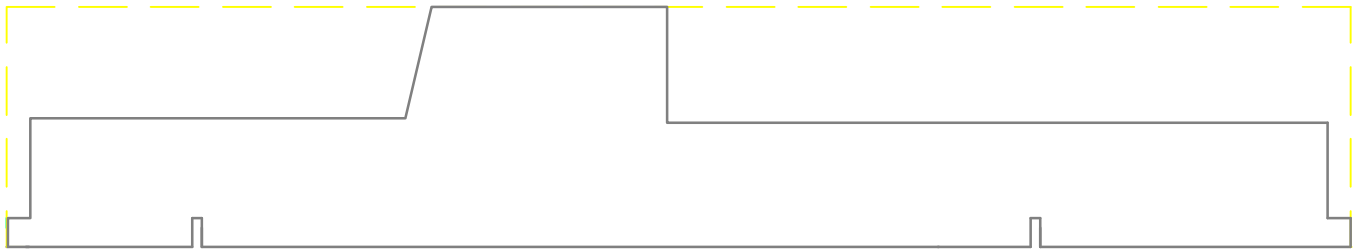
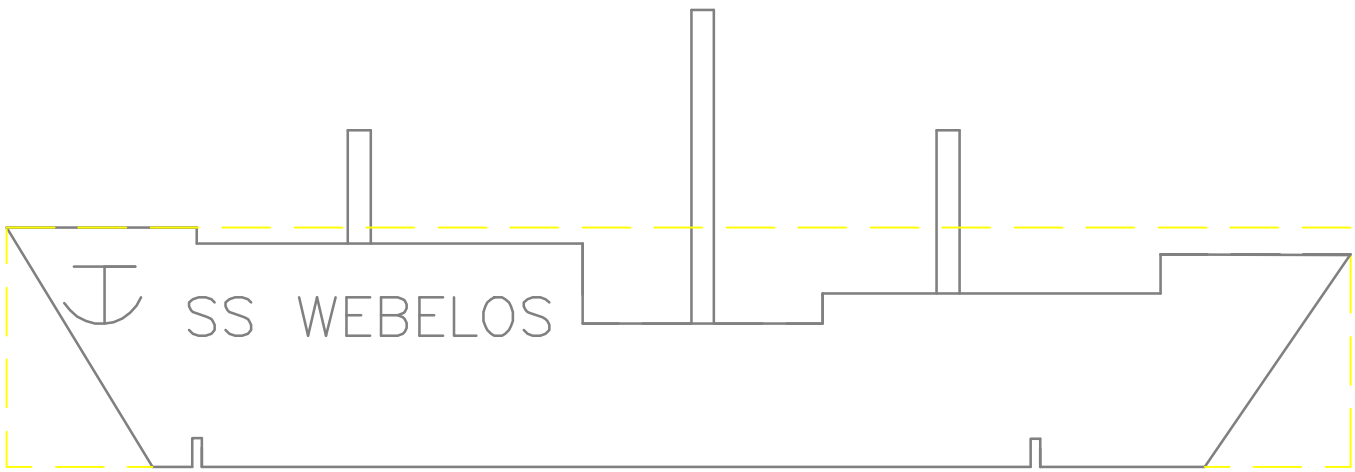
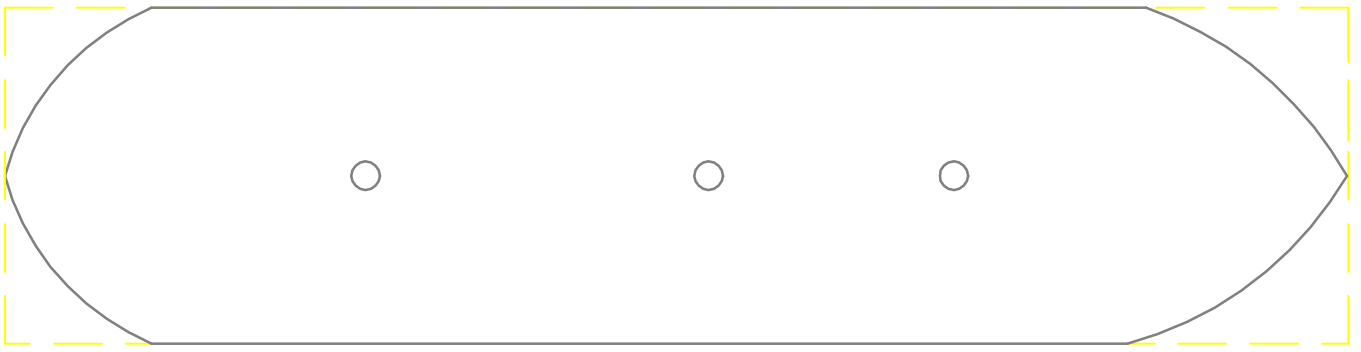

GLUE ON ROUNDED 1/2" DOWEL

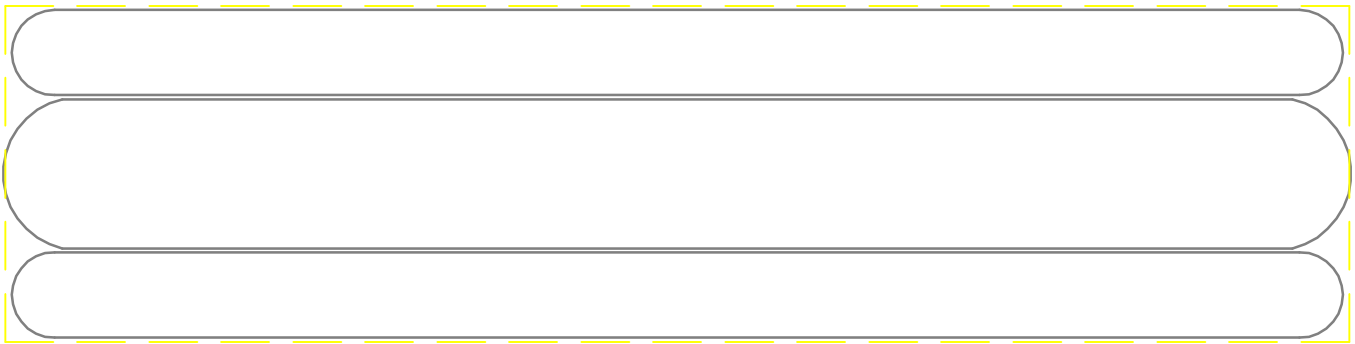
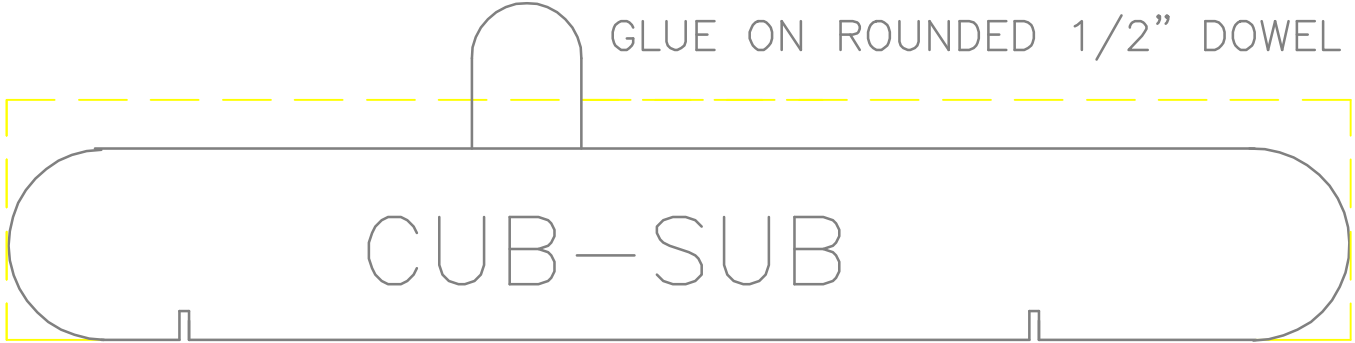

HOTDOGGER TOP VIEW

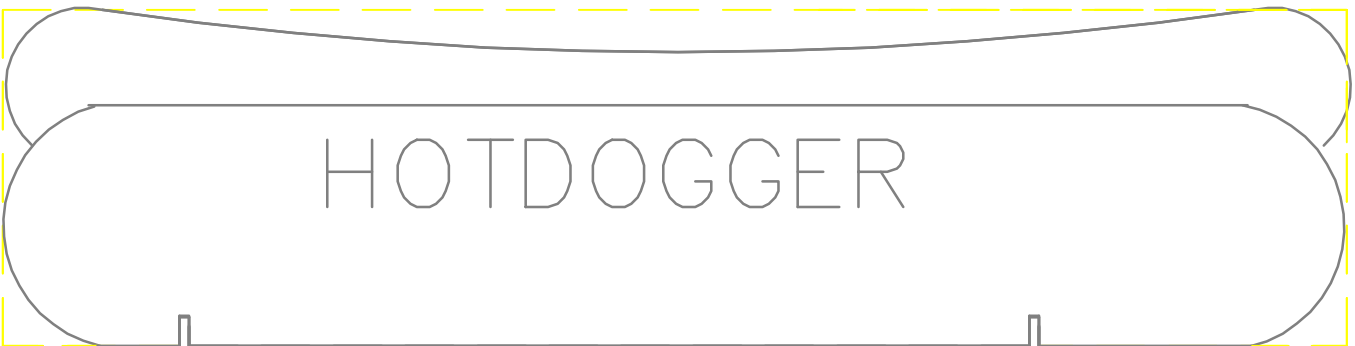

GLUE ADDITIONAL WOOD FOR HEIGHT

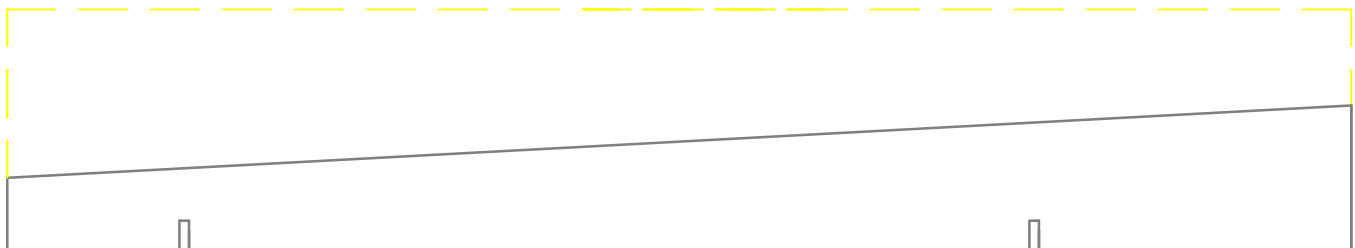

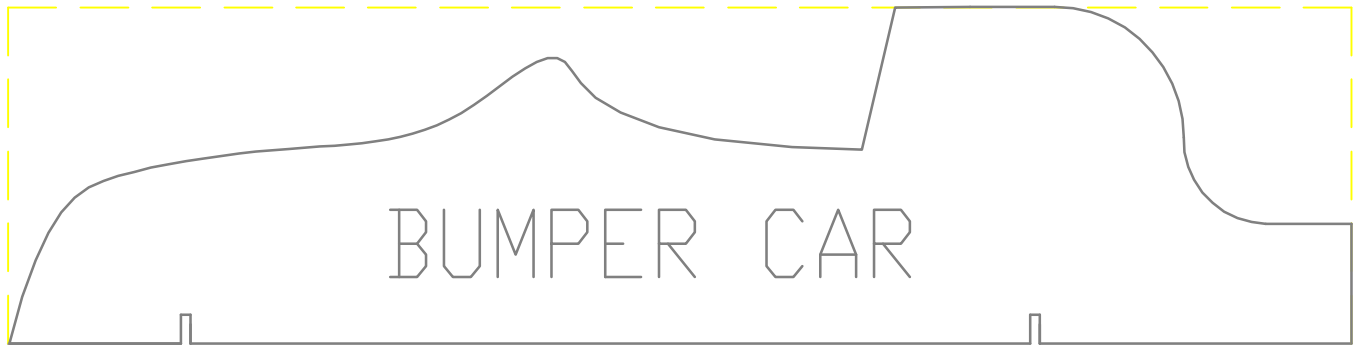

GLUE EXTRA WOOD FOR ADDITIONAL HEIGHT

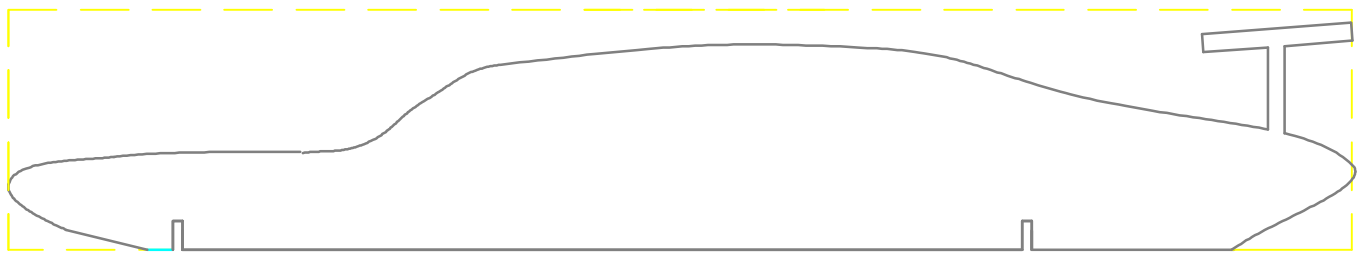

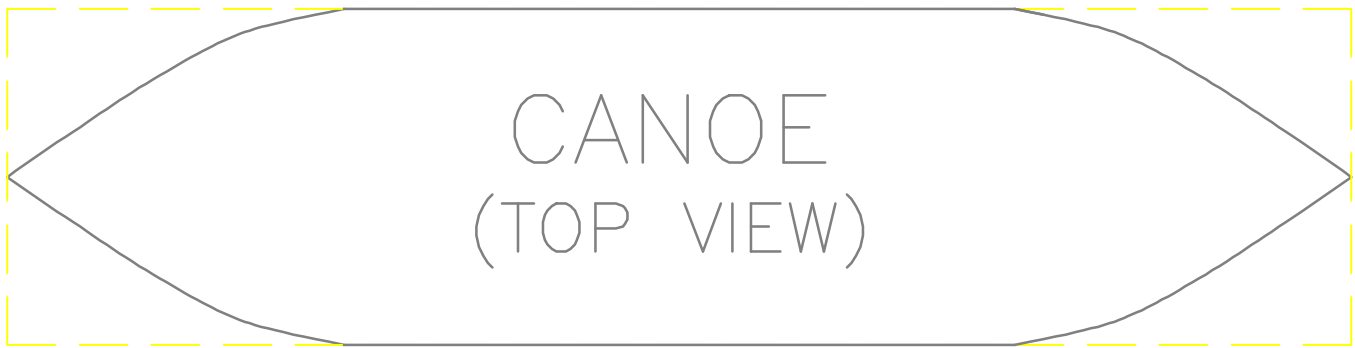
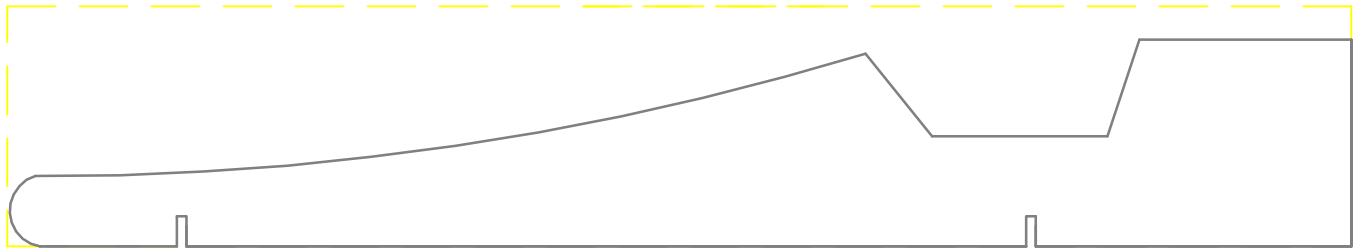
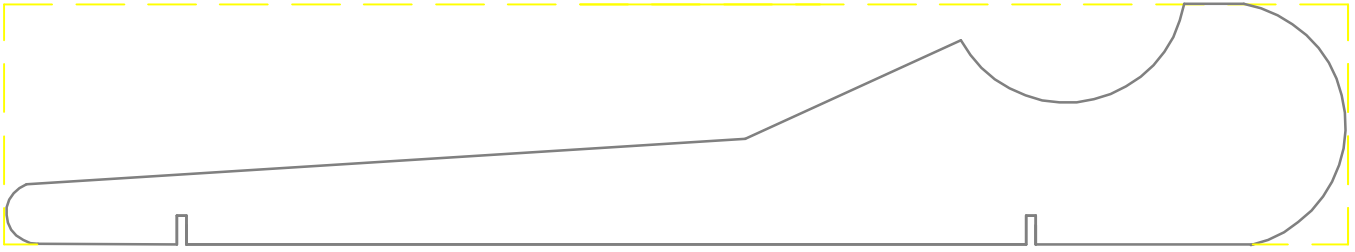

REQUIRES EXTRA HEIGHT

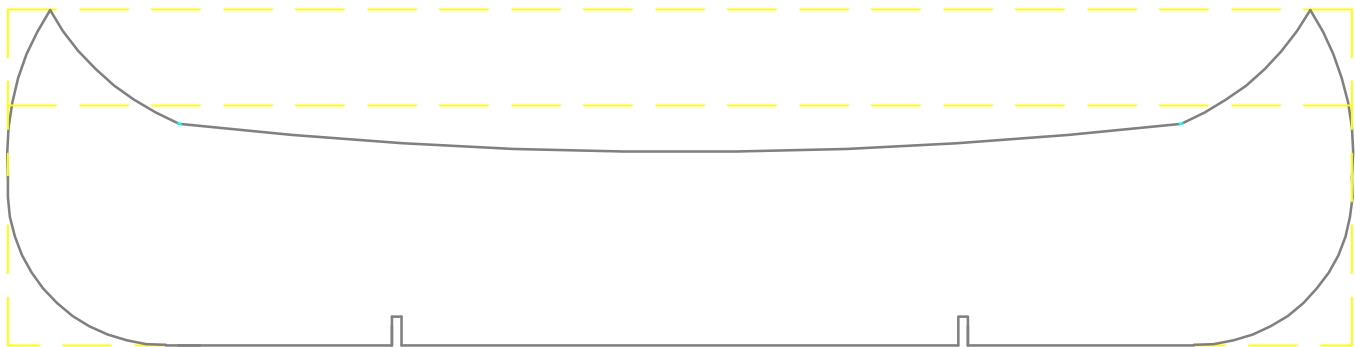

SHORTEN WHEELBASE

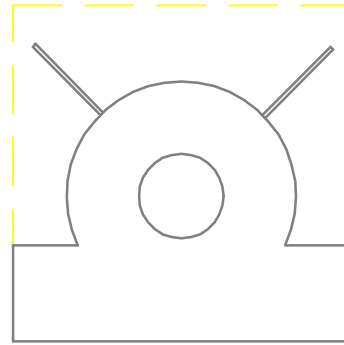
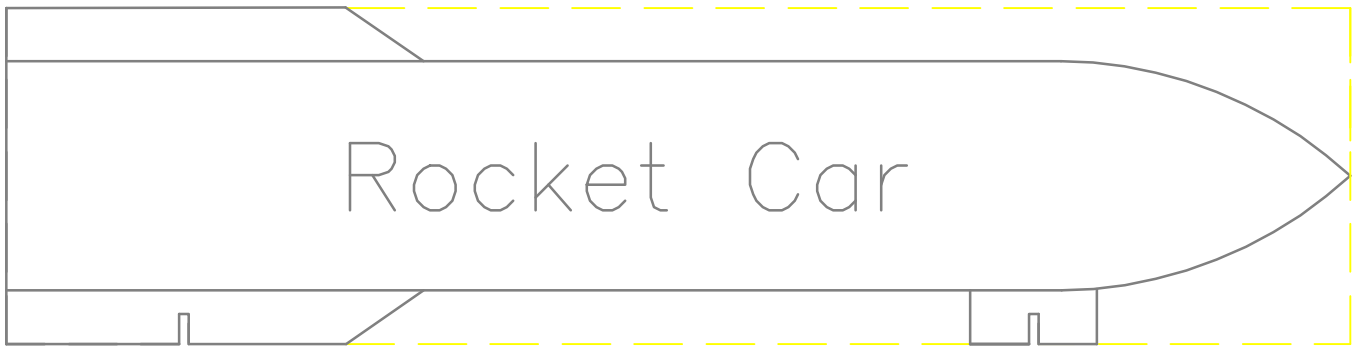

END VIEW

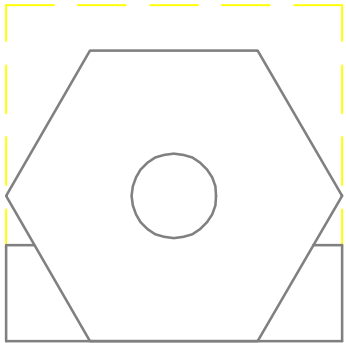

END VIEW

GLUE ADDITIONAL WOOD FOR THESE DESIGNS

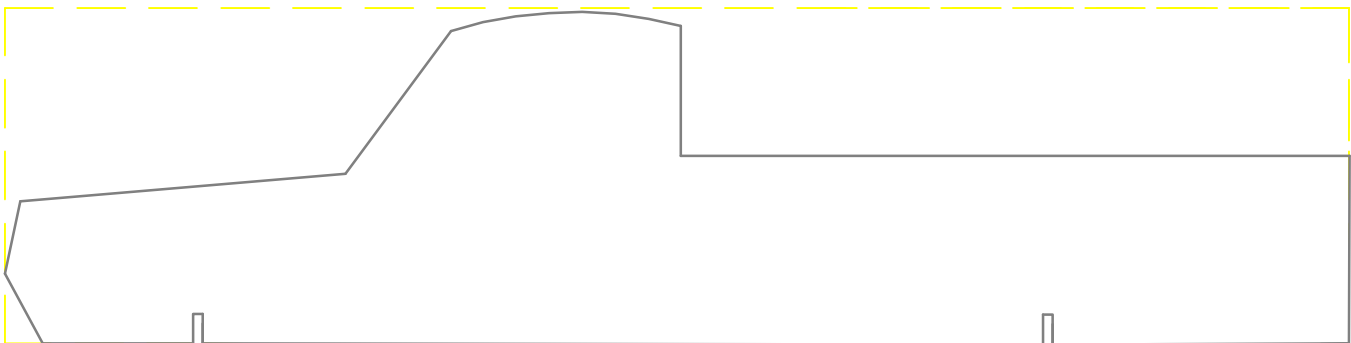
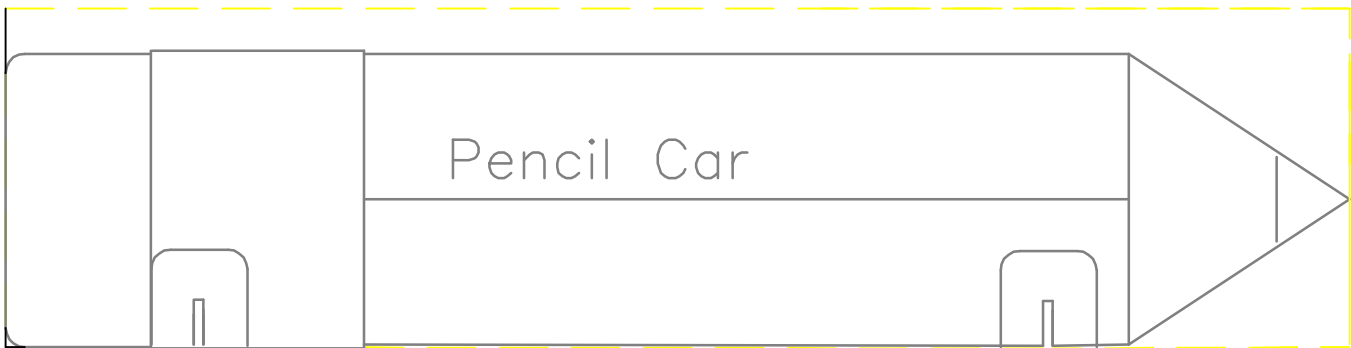

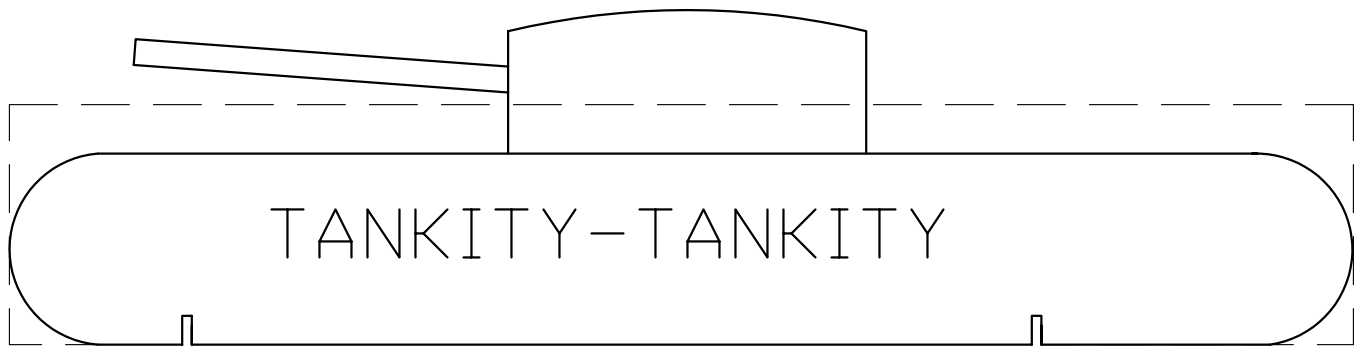

TANKITY-TANKITY

ADD WOOD FOR TURRET AND BARREL



ADD WEIGHT IN 3/8" HOLES

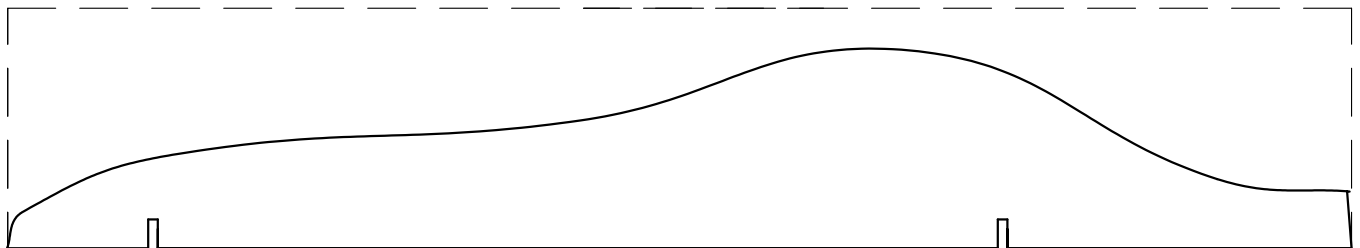
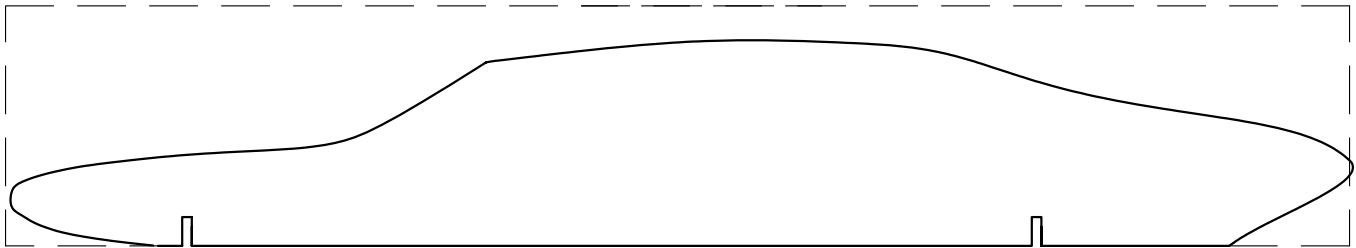

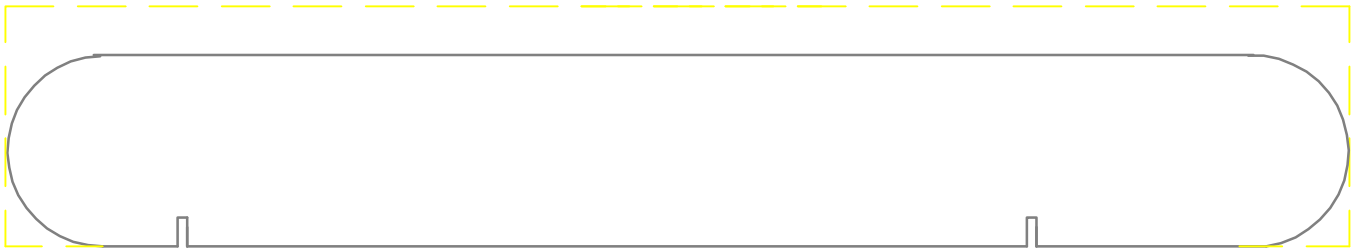
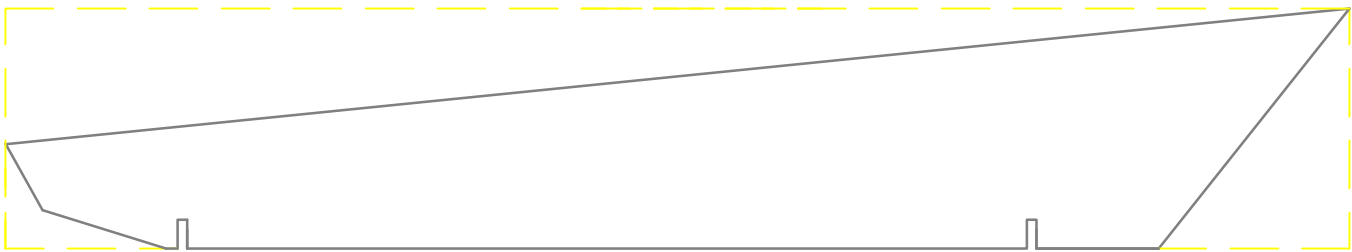
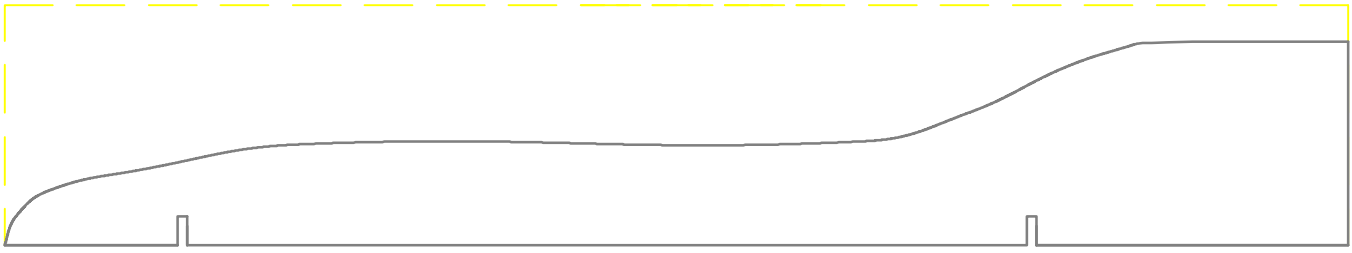

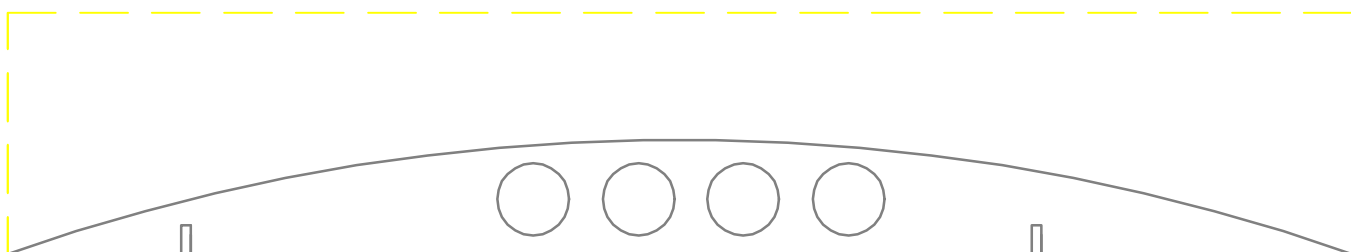
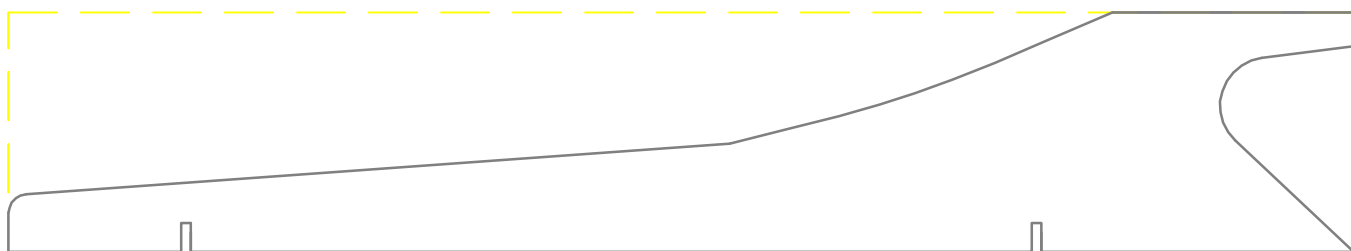

3/8" HOLES FOR WEIGHT

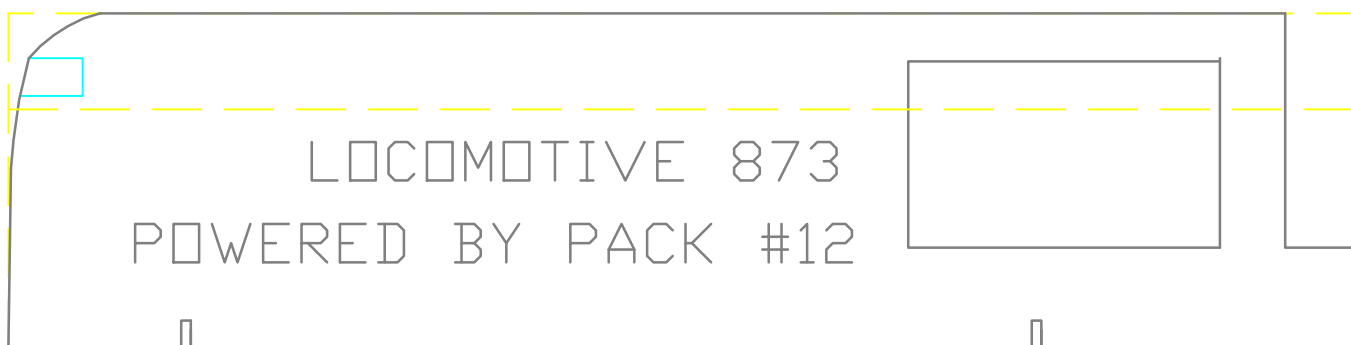

LOCOMOTIVE 873
POWERED BY PACK #12

GLUE EXTRA WOOD TO BLOCK FOR REQUIRED HEIGHT

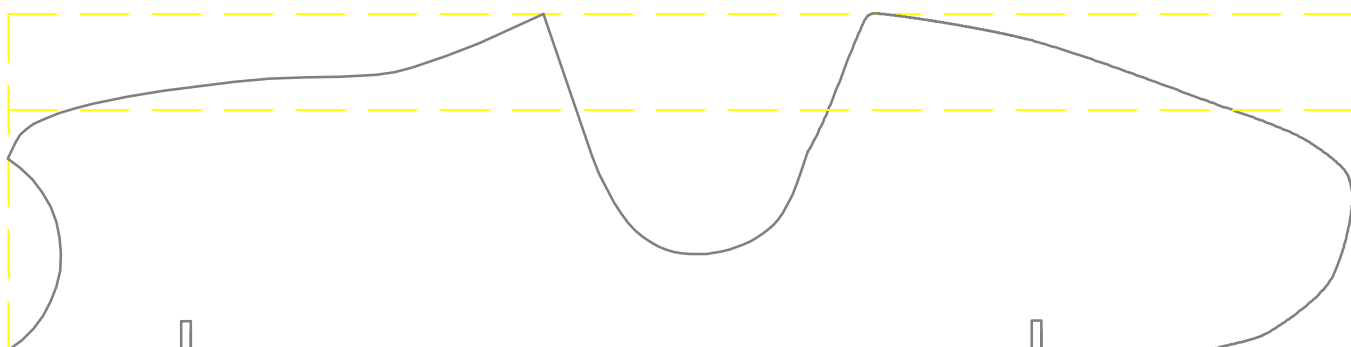

GLUE EXTRA WOOD TO BLOCK FOR REQUIRED HEIGHT

THE CRAYON CAR CAN BE CUT FROM THE STANDARD BLOCK THEN ROUTED TO REMOVE WOOD TO PROVIDE SPACE FOR ACTUAL CRAYONS TO BE INSERTED AS SHOWN. THE PAINT SCHEME COLORS DEPICT REALISTIC COLORS THAT MIGHT BE FOUND ON COMMERCIAL BOXES.

